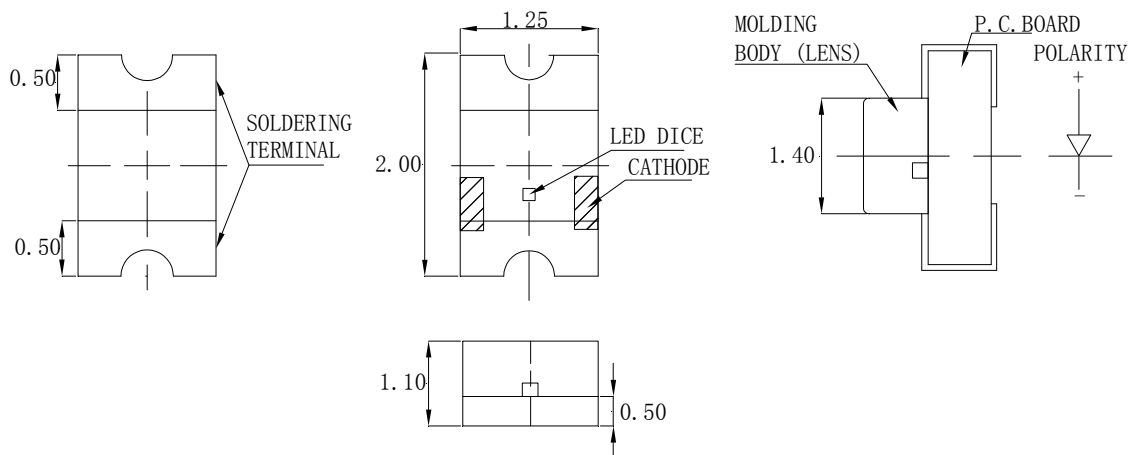

Features

- 2.0mm*1.25mm SMT LED, Super thin (1.10H mm)
- Low Power Consumption
- Wide Viewing Angle
- Various Colors
- Compatible with automatic placement equipment.
- Compatible with infrared and vapor phase reflow and wave solder process.
- Meet ROHS Green Products
- Package: 3000pcs/Reel

Applications

- Backlight and Indicator

Package Dimensions**Notes:**

1. All dimensions are in millimeters (inches).
2. Tolerance is $\pm 0.2\text{mm}$ (.0079") unless otherwise noted.
3. Specifications are subject to change without notice
4. This drawing is only for reference, not as a basis for the actual structure.



Selection Guide

Part No	Lens Type	Dice	Emitted Color
FSL-20125110R-TCNHB	Water Clear	AllnGap	Red

Electrical / Optical Characteristics At Ta=25°C

Symbol	Parameter	Min.	Typ.	Max.	Unit	Test Condition
Iv	Luminous Intensity	165	300		mcd	IF=20mA
2θ1/2	Viewing Angle		130		deg	IF=20mA
λ Peak	Peak Emission Wavelength		639		nm	IF=20mA
λ d	Dominant Wavelength		625		nm	IF=20mA
Δλ	Spectral Line Half-Width		20		nm	IF=20mA
VF	Forward Voltage	1.6	2.1	2.6	V	IF=20mA
IR	Reverse Current			10	μ A	VR 5V

Note:

1. θ1/2 is the angle from optical centerline where the luminous intensity is 1/2 optical centerline value

Absolute Maximum Ratings At Ta=25°C

Parameter	Red	Unit
Power Dissipation	75	mW
Peak Forward Current[1]	80	mA
Continuous Forward Current	30	mA
Dreading Linear From 25°C	0.4	mA/°C
Reverse Voltage	5	V
Electrostatic Discharge Threshold(HBM)	2000	V
Operating Temperature Range	-55°C to + 85°C	
Storage Temperature Range	-55°C to + 85°C	
Soldering Condition	260°C For 5 Seconds	

Note:

1. 1/10DutyCycle, 0.1msPulseWidth

Electrical Optical Characteristics Curves At Ta=25°C

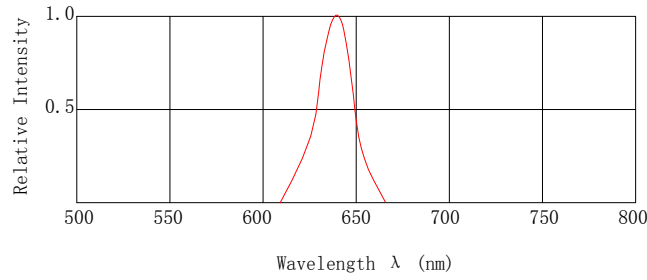

Fig.1 Relative Intensity vs. Wavelength

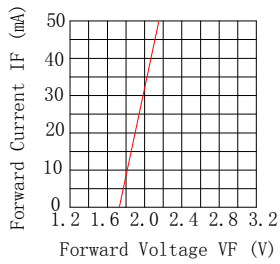

Fig.2 Forward Current VS. Forward Voltage

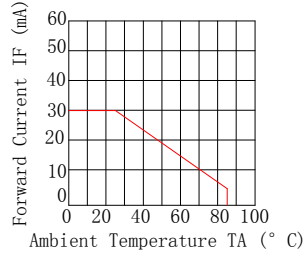

Fig.3 Forward Current Derating Curve

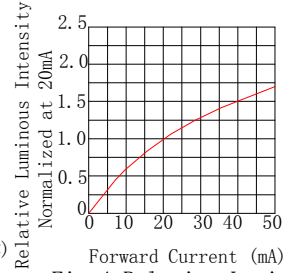

Fig.4 Relative Luminous Intensity VS. Forward Current

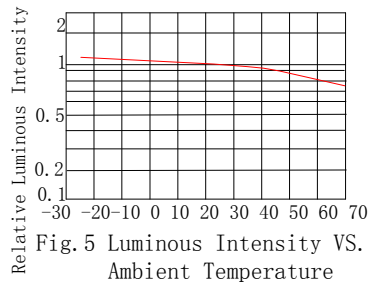

Fig.5 Luminous Intensity VS. Ambient Temperature

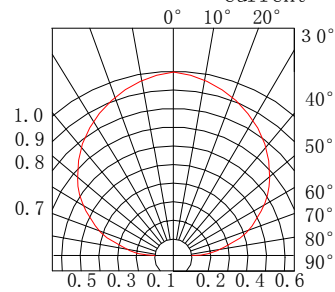
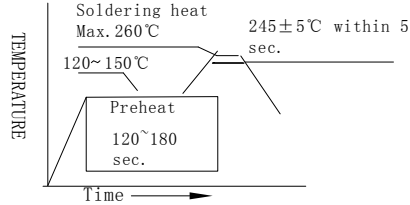

Fig.6 Spatial Distribution

SMT Reflow Soldering Instructions



Notes:

1. Sells gives no other assurances regarding the ability of to withstand ESD. It is recommended to use a wrist band or anti-electrostatic glove when handling the LED. All devices, equipment and machinery must be properly grounded.
2. Reflow soldering should not be done more than two times.
3. Do not stress LED when soldering, and do not warp the circuit board after soldering
4. While using Iron, Power dissipation of Iron should be smaller than 25W, and temperature should be controllable. The work should be finished within 2 sec under 320°C for once only.

Recommended Soldering Pad Dimensions

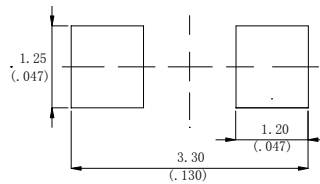

Package Specifications (Units: mm (inches))

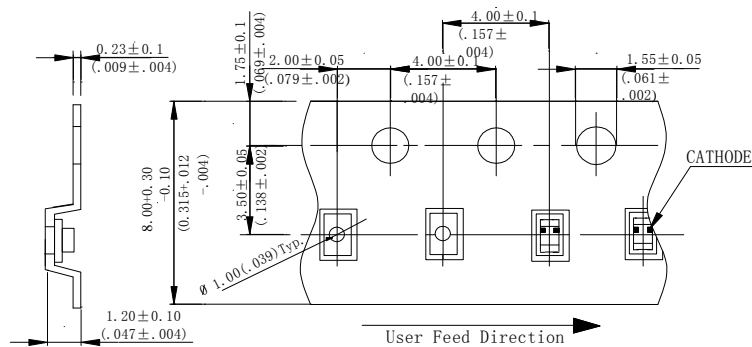

Notes:

1. The LEDs should be used within a year.
2. The LEDs should be kept in 5~30°C and 60% RH for less.
3. The LEDs should be used within 24 hours, or else should be kept a 5~30°C and 30% RH or less. And LEDs should be used within 7 days after opening the package.

Reliability Test Items Conditions

Classification	Test Item	Test Conditions	Test hours	Result
Endurance Test	Opertion Life	Connect with a power if=20mA Ta=Under room temperature	1000Hrs	0/20
	Hige Temperature High Humidity	Ta=+ 65°C±5°C RH=90%-95%	240Hrs	0/20
	Hige Temperature Storage	High Ta=+ 85°C±5°C	1000Hrs	0/20
	Low Temperature Storage	Low Ta=-35°C±5°C Test time=1000hrs	1000Hrs	0/20
Environmental Test	Temperature Cycling	-45°C ~+105°C 15min 5min 15min	300 Cycles	0/20
	Thermal Shock	-35°C ~±5°C ~+85°C ~±5°C 5min 10sec 5min	300 Cycles	0/20
	Solder Resistance	Preheating: 120°C-150°C,within 2 minutes. Operation heating : 260°C (Max.),within5 seconds(Max.)	5Cycles	0/20

Judgment criteria of fialure for the reliability

Measuring items	Symbol	Measuring conditions	Judgment criteria for failure
Forward voltage	V _F (V)	I _F =20mA	Over U×1.2
Revevrse current	I _R (μA)	V _R =5V	Over U×2
Luminous intensity	I _v (mcd)	I _F =20mA	Below S×0.5

Note: 1.U means the upper limit of specified characteristics. S means initial value.

2.Meansurment shall be taken between 2 hours after the test pieces have been returned to normal ambient conditions after completion of each test.